

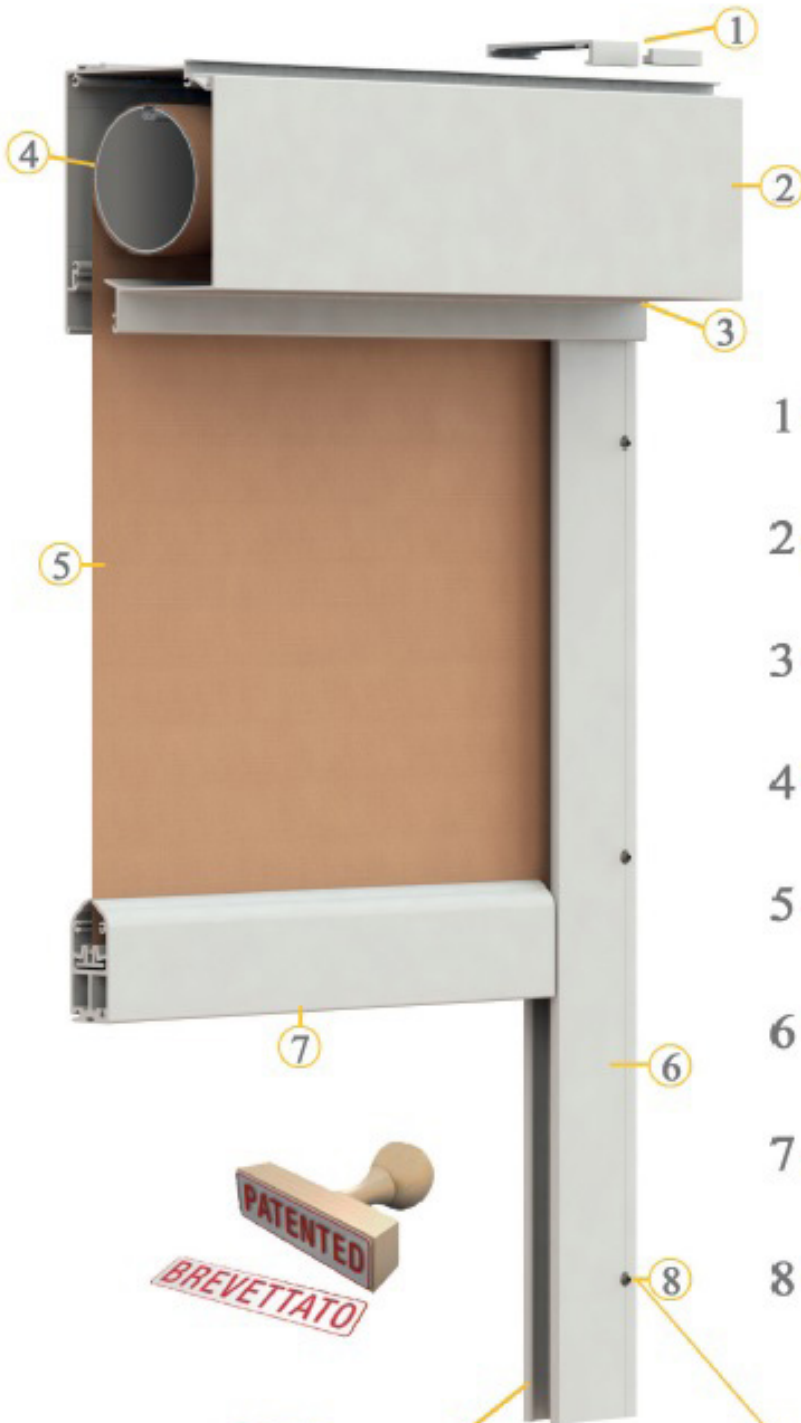

# **ZIPPY XL**

**OUTDOOR TECHNICAL BLINDS**



- 1 MOUNT
- 2 ALUMINIUM BOX
- 3 CONTROL
- 4 ROLLER TUBE
- 5 FABRIC
- 6 LATERAL GUIDE
- 7 BOTTOM BAR
- 8 GUIDE LOCK SYSTEM



**ZIPPY XL IS THE IDEAL SOLUTION TO PROTECT AND SHELTER ALL KINDS OF SPACES.**

THERE ARE VARIOUS MODELS AVAILABLE. THEY ALL FEATURE ADJUSTABLE SIDE GUIDES WITH ZIP TECHNOLOGY THAT GUARANTEES EXCELLENT FABRIC HOLD WITH CONSEQUENT EXCELLENT WIND RESISTANCE RESULTS.

## MOUNT

INSPECTABLE VULCANO BOX: DIRECT FRONT OR CEILING MOUNT WITH SCREWS OR CEILING MOUNT WITH BRACKETS.

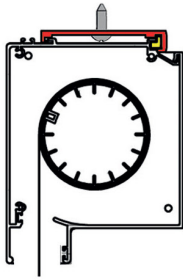

CEILING MOUNT  
WITH BRACKETS

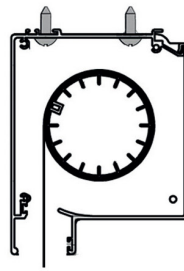

DIRECT CEILING MOUNT  
WITH SCREWS

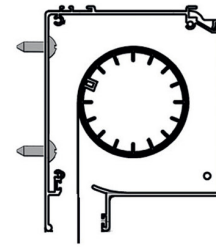

DIRECT FRONT MOUNT  
WITH SCREWS

## ALUMINIUM BOX

110 INSPECTABLE VULCANO BOX IS AVAILABLE IN A ROUND OR SQUARED VERSION. METAL END CAPS ARE COATED IN THE SAME COLOUR AS THE ALUMINIUM STRUCTURE.

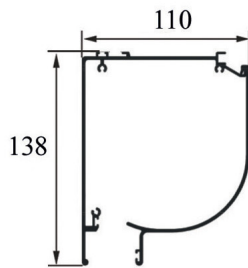

ROUND  
VERSION

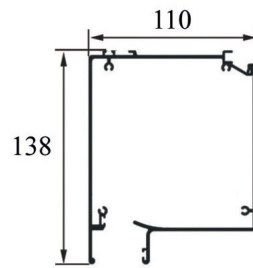

SQUARED  
VERSION

## END CAPS FOR LATERAL FIXING

ON REQUEST, IT IS POSSIBLE TO ORDER END CAPS FOR A LATERAL FIXING.

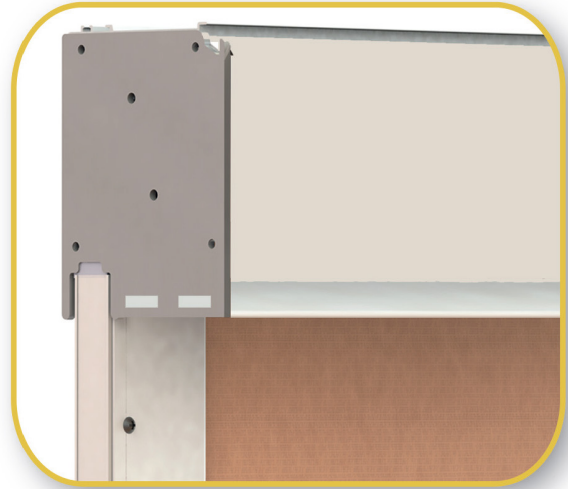
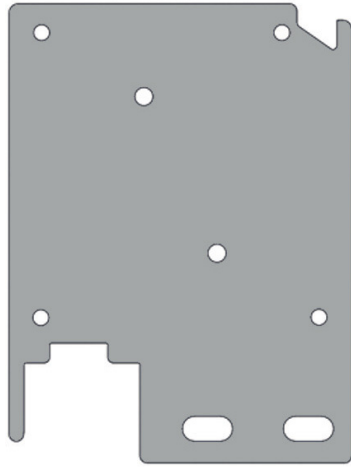

## EASY MAINTENANCE SYSTEM

### IRON ROLLER TUBE Ø 80 AND ZIPPY XL BOTTOM BAR WITH ZIP HOUSING.

ZIP IS WELDED ON 4 FABRICS SIDES.

IT IS VERY IMPORTANT BECAUSE IT SPEEDS UP ASSEMBLY OPERATIONS AS ANY FABRIC REPLACEMENT / MAIN-

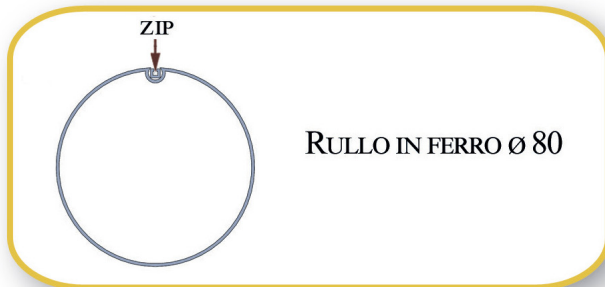

## ROLLER RELEASE

IN LIGHT VERSIONS, USING THE INSPECTABLE VULCANO BOX, THE ROLLER TUBE CAN BE REMOVED WITHOUT HAVING TO DISMANTLE THE BLIND.

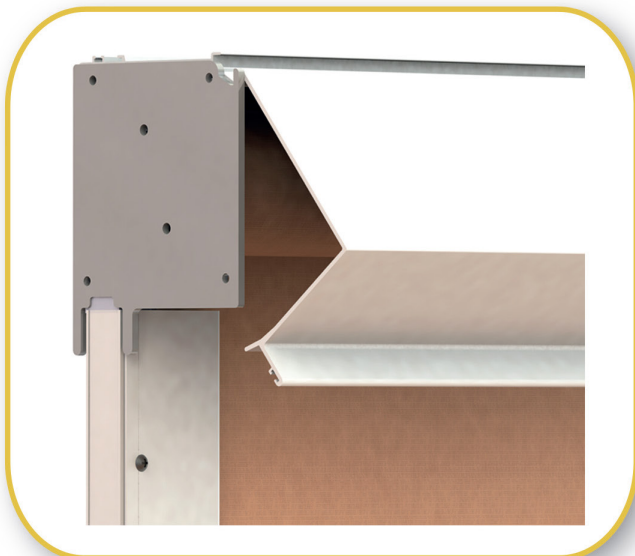

## ZIPPY XL BOTTOM BAR WITH ZIP HOUSING

ZIPPY XL BOTTOM BAR WITH PVC GUIDE HOLDER (PVC GUIDE FOR ZIP RETENTION) AND WEIGHT IN THE LOWER PART.

IN CASE OF GEAR OPERATION, A LOCK SYSTEM CAN BE INSTALLED ON THE BOTTOM BAR TO MANUALLY TIGHTEN THE FABRIC.

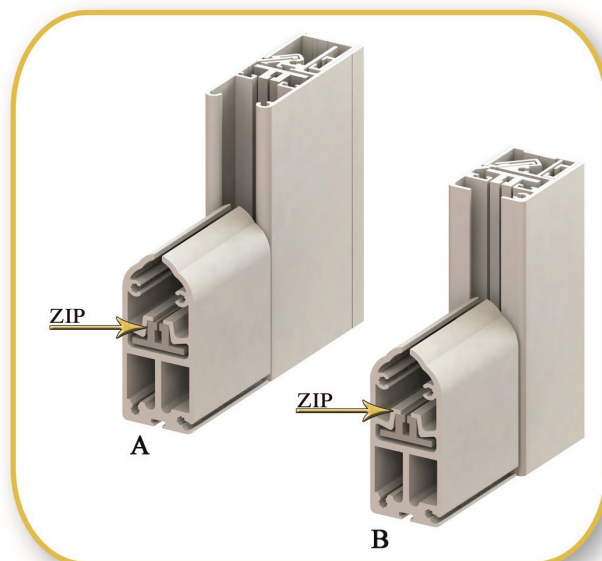

POSSIBLE COMBINATIONS BETWEEN DIFFERENT TYPES OF BOTTOM BAR AND ZIPPY SIDE GUIDES.  
A) ZIPPY SIDE GUIDE + ZIPPY XL BOTTOM BAR  
B) ZIPPY SLIM SIDE GUIDE + ZIPPY XL BOTTOM BAR

## LOCK SYSTEM

IN CASE OF GEAR OPERATION, A LOCK SYSTEM CAN BE INSTALLED ON THE BOTTOM BAR TO MANUALLY TIGHTEN THE FABRIC.

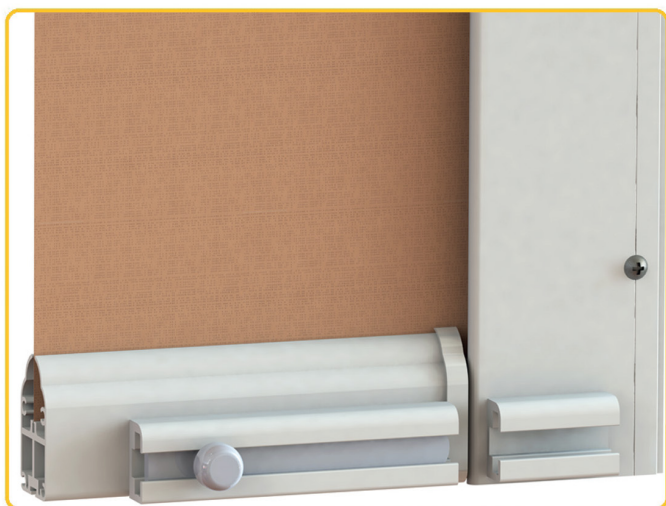

## VALANCE

ON REQUEST, THERE IS THE POSSIBILITY TO ADD A VALANCE TO THE BOTTOM BAR.



## GASKET

ON REQUEST, THERE IS THE POSSIBILITY TO ADD A GASKET PROFILE (13 MM) TO THE BOTTOM BAR. AVAILABLE IN BLACK AND GREY

## ZIPPY ADJUSTABLE SIDE GUIDE

ZIPPY SIDE GUIDE IS AVAILABLE IN 3 VERSIONS AND CAN BE CHOSEN ACCORDING TO CUSOMER'S NEEDS.

1. ZIPPY SIDE GUIDE FOR LATERAL FIXING;
2. ZIPPY SIDE GUIDE FOR FRONT FIXING;
3. ZIPPY SLIM GUIDE FOR A SIDE FIXING;

ALL ZIPPY SIDE GUIDES ARE ADJUSTABLE AND MADE UP OF 3 ALUMINIUM PROFILES TO RECOVER UP 1,8 CM. OFFSET FOR ZIPPY SLIM SIDE GUIDE (3) AND UP TO 3 CM. OFFSET FOR ZIPPY SIDE GUIDE (1-2).

GUIDE LOCK SYSTEM WITH SCREWS. SCREWS ARE HIDDEN WITH PLASTIC CAPS AVAILABLE IN 4 COLOURS.

BRUSH IS INSTALLED INSIDE THE SIDE GUIDES IN ORDER TO REDUCE NOISE CAUSED BY CONTACT BETWEEN PVC GUIDE AND ALUMINIUM GUIDE.

PVC GUIDE GUARANTEES A PERFECT ZIP RETENTION

ZIP IS WELDED ON 4 FABRIC SIDES . AVAILABLE IN GREY, WHITE AND BLACK COLOUR. (BLACK IS ALWAYS USED WITH BLACKOUT FABRIC).

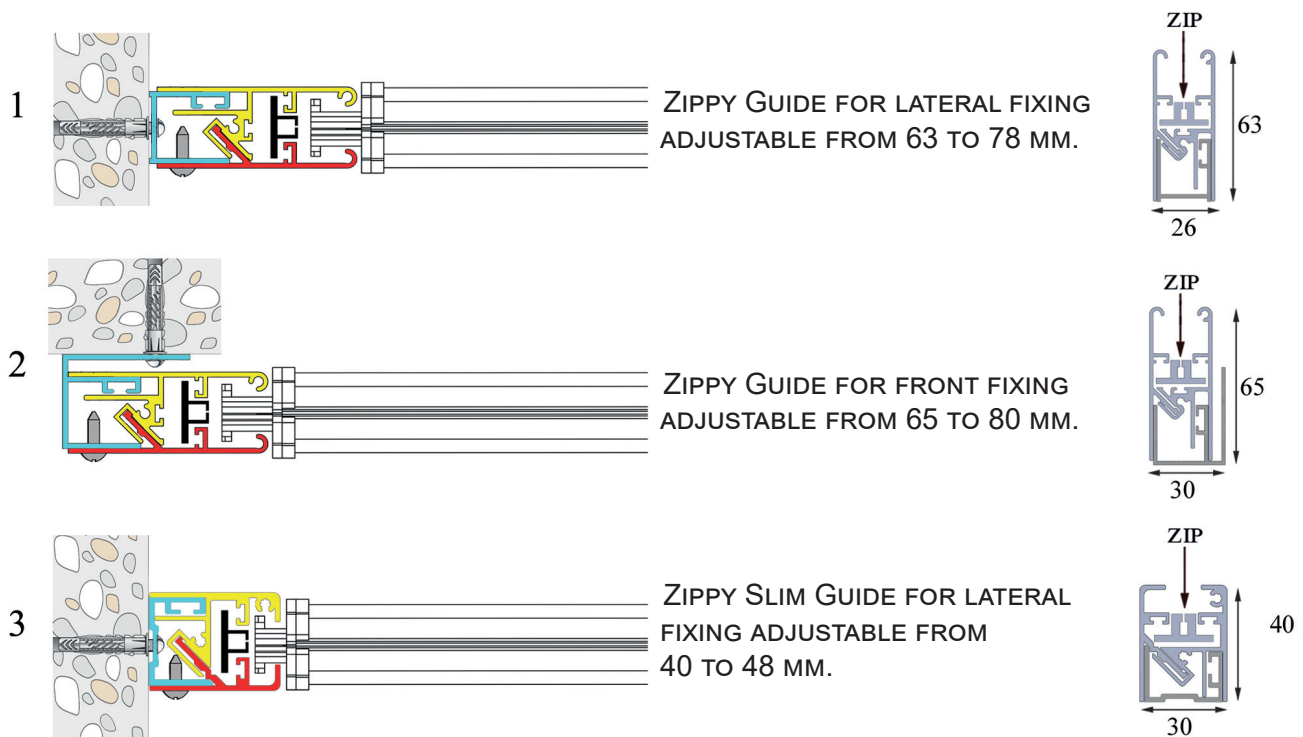

## SCREW CAPS

ELEGANT NYLON SCREW CAPS ARE AVAILABLE IN 4 COLOURS: BLACK, WHITE, IVORY AND BROWN.



## TUBULAR PROFILES

THEY ARE USED FOR CORNER INSTALLATION OR AS UPRIGHTS BETWEEN TWO BLINDS

\* CUTOUT FOR TUBULAR  
INSERTION INTO THE PLATE

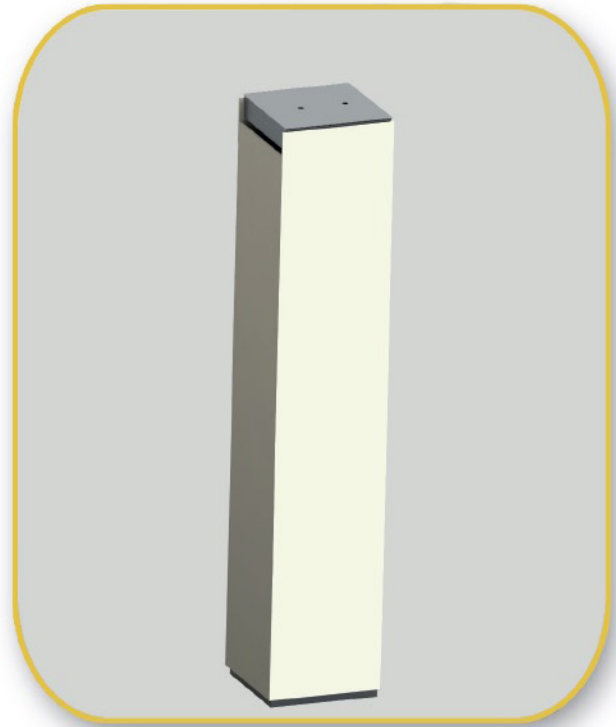
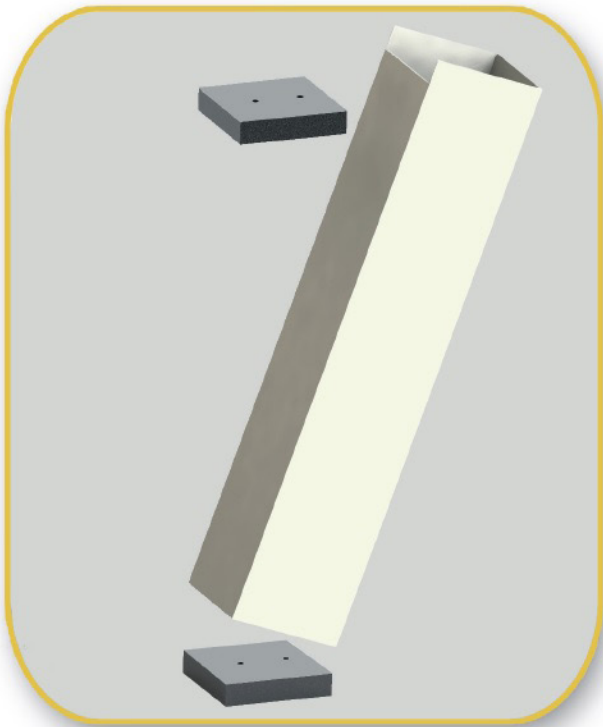
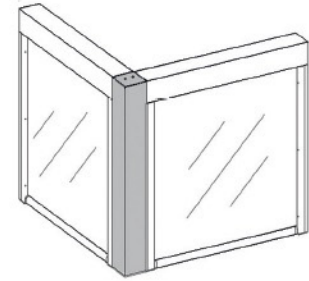
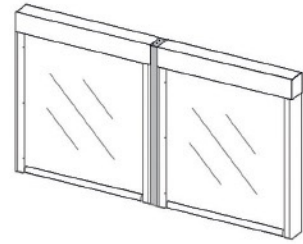
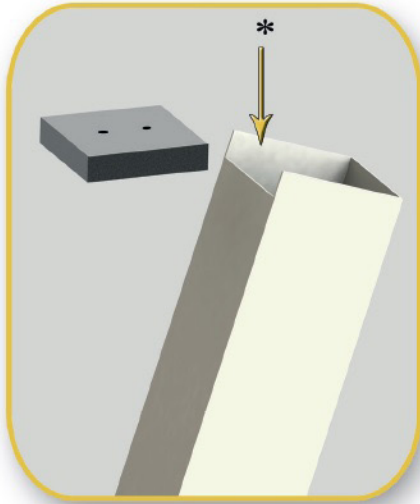

## CONTROL

ZIPPY XL CAN BE GEAR OR MOTOR OPERATED.

## GEAR

GEAR OPERATION WITH FIXED ROD (A) OR REMOVABLE MAGNET ROD (B).

IN CASE OF MAGNETIC ROD, UNLESS OTHERWISE SPECIFIED ON ORDER FORM, ONE HANDLE WILL BE SUPPLIED FOR EACH ORDER.

ON REQUEST A LOCK SYSTEM CAN BE INSTALLED ON THE BOTTOM BAR TO MANUALLY TIGHTEN THE FABRIC.



## MOTOR

MOTOR CAN BE WITH WIRED DRIVES OR ELECTRONIC SETTING WITH REMOTE CONTROL.

AVAILABLE MOTORS: CHERUBINI, SOMFY AND GAPOSA.

## FABRICS

VARIOUS FABRIC ARE USED IN ZIPPY SYSTEM: POLYESTER INSECT SCREEN MAGICSCREEN, SOLTIS SHADING, OPATEX BLACKOUT AND TRANSPARENT PVC (CRISTAL).

MAGICSCREEN IS AVAILABLE IN BLACK COLOUR.

IT IS SO STRONG THAT IT RETURNS TO THE CORRECT POSITION IF IT EXPERINCES SMALL PERFORATIONS.

## WELDING

ALL FABRICS ARE HORIZONTALLY WELDED.

## COATING AND SCREWS

ALL ALUMINIUM PROFILES UNDERGO AN OPEN-PORE ANODIC OXIDATION PRETREATMENT.

THEN, THE POWDER COATING ON THE ALUMINIUM HAS HIGHT MECHANICAL PROPERTIES AND INCREASE PROTECTION AGAINST CORROSION AND AGGRESSIVE ATMOSPHERE.

STAINLESS STEEL SCREWS.

## WIND RESISTANCE

GARATTONI TESTS ALL AWNINGS TO CHECK THEY RESIST TO WIND IN ACCORDANCE TO UNI EN 13561.

TESTED SIZE: 5 M X 3 M – CLASS 5 (83 KM/H)







## TEST ZIPPY XL



**TESTED SAMPLE**  
**5 x 3 MT**



# Garattoni

LIVING | INNOVATION

**GARATTONI DARIO DI R.I.**

VIA DEL SALICE, 8 - 47822 SANTARCANGELO DI ROMAGNA (RN)

TEL. 0039.0541.625648

WWW.GARATTONIDARIO.COM - INFO@GARATTONIDARIO.COM







## TEST ZIPPY XL



**TESTED SAMPLE**  
**3 x 3 MT**

